





















# Snow plow for ATV

Material: steel

## Main parts of snow plow set

No	QTY	Name	View	No	QTY	Name	View
1	2	Bush		11	13	Nut M10	
2	2	Spring		12	4	Nut M12	
3	2	Bolt M10x25		13	4	Washer 12	
4	2	Bolt M10x30		14	3	Bolt M10x40	
5	7	Bolt M10x35 (furniture)		15	2	Bolt M6x20	
6	2	Screw loop M10x60x10		16	11	Washer 10	
7	3	Screw lamb M10x16.016		17	2	Support	
8	2	SD 3005		18	2	Washer 6	
9	2	Special washer		19	1	Spring fixator spacer	
10	2	Nut M6		20	1	Spring fixator	
				21	1	ATV universal mount plate	

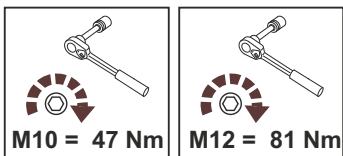

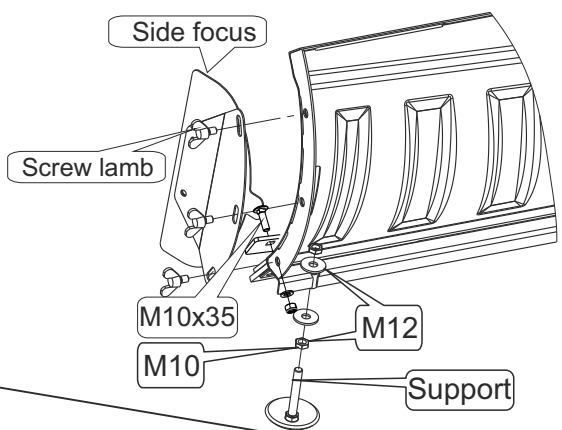

1

2

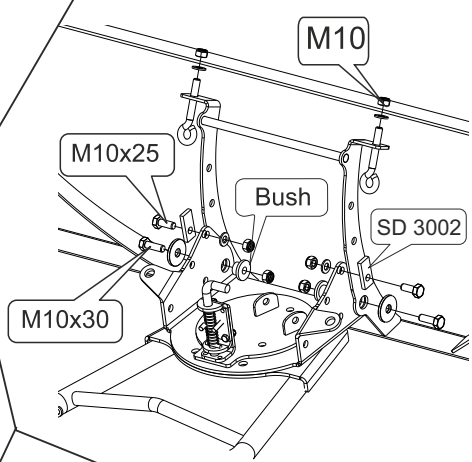

4

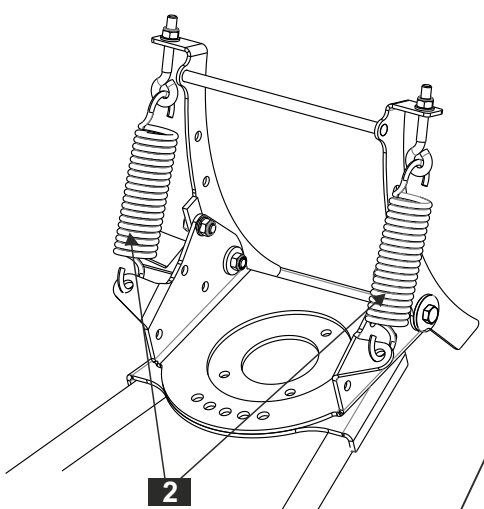

3

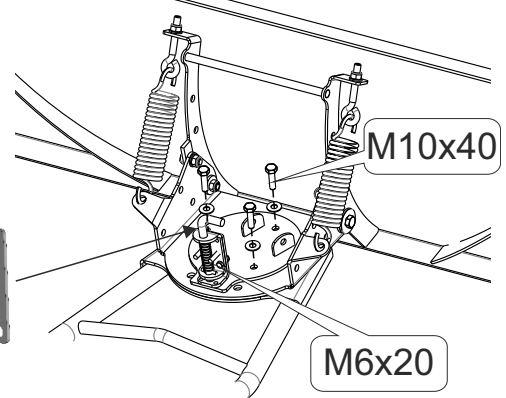

5

