















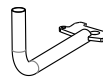







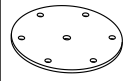









Snow plow for ATV

Material: steel

Main parts of snow plow set № 40.MP 0700 V1/V2

№	QTY	Name	View	№	QTY	Name	View
1	2	Support		16	8	Bolt M8x25	
2	1	Slide stop		17	2	Bolt M10x20	
3	1	Push tubes		18	2	Bolt M10x30	
4	1	Plow		19	2	Bolt M10x40	
5	1	Blade adjustment dial		20	7	Bolt M10x35	
6	2	Spring		21	2	Screw lamp	
7	1	Blade adjustment plate		22	2	Screw loop	
8	2	Turning disk stop		23	8	Nut M8	
9	1	Turning disk		24	15	Nut M10	
10	1	Rubber blade		25	2	Nut M12	
11	1	Blade		26	6	Washer 8	
12	6	Spacer		27	15	Washer 10	
13	1	Mount plate		28	2	Washer 12	
14	2	Skid shoes		29	8	Washer 8G	
15	1	Plate		30	8	Washer 8	
				31	4	Washer 10	

№	Кол-во	Наимено-вание	Вид
32	1	Spring	
33	2	Spring retainer	
34	4	Clamp	

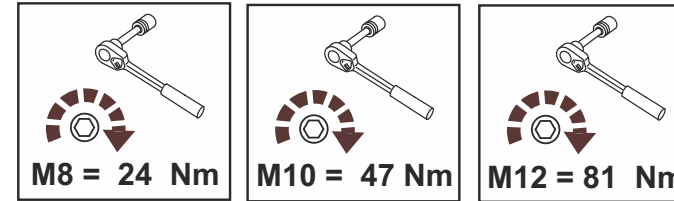

40.MP 0700V1
40.MP 0700V2

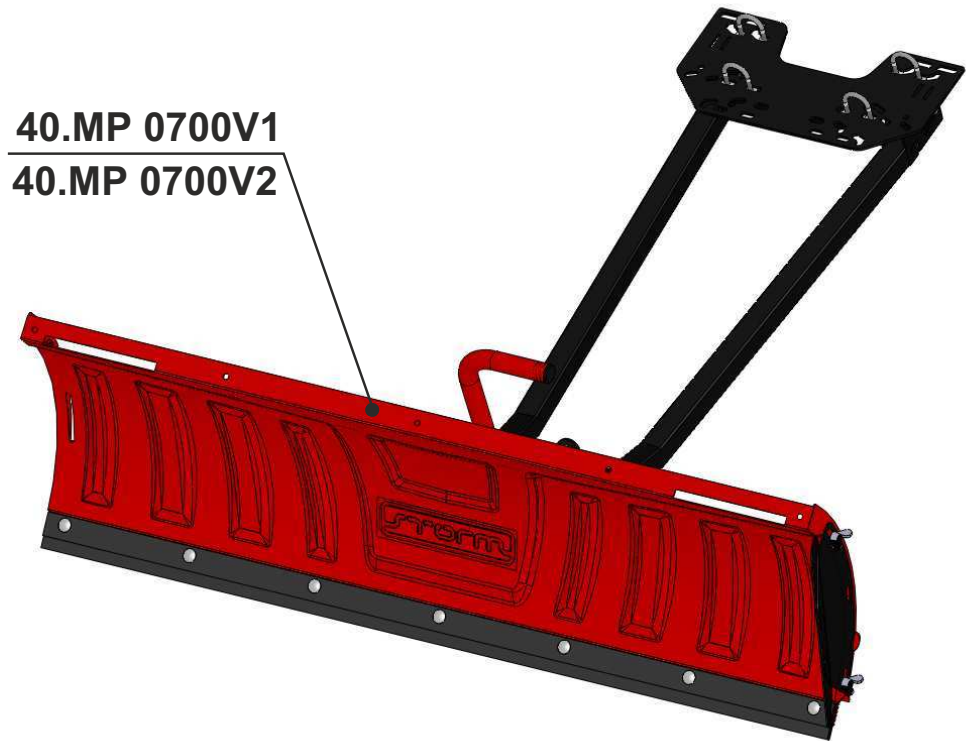

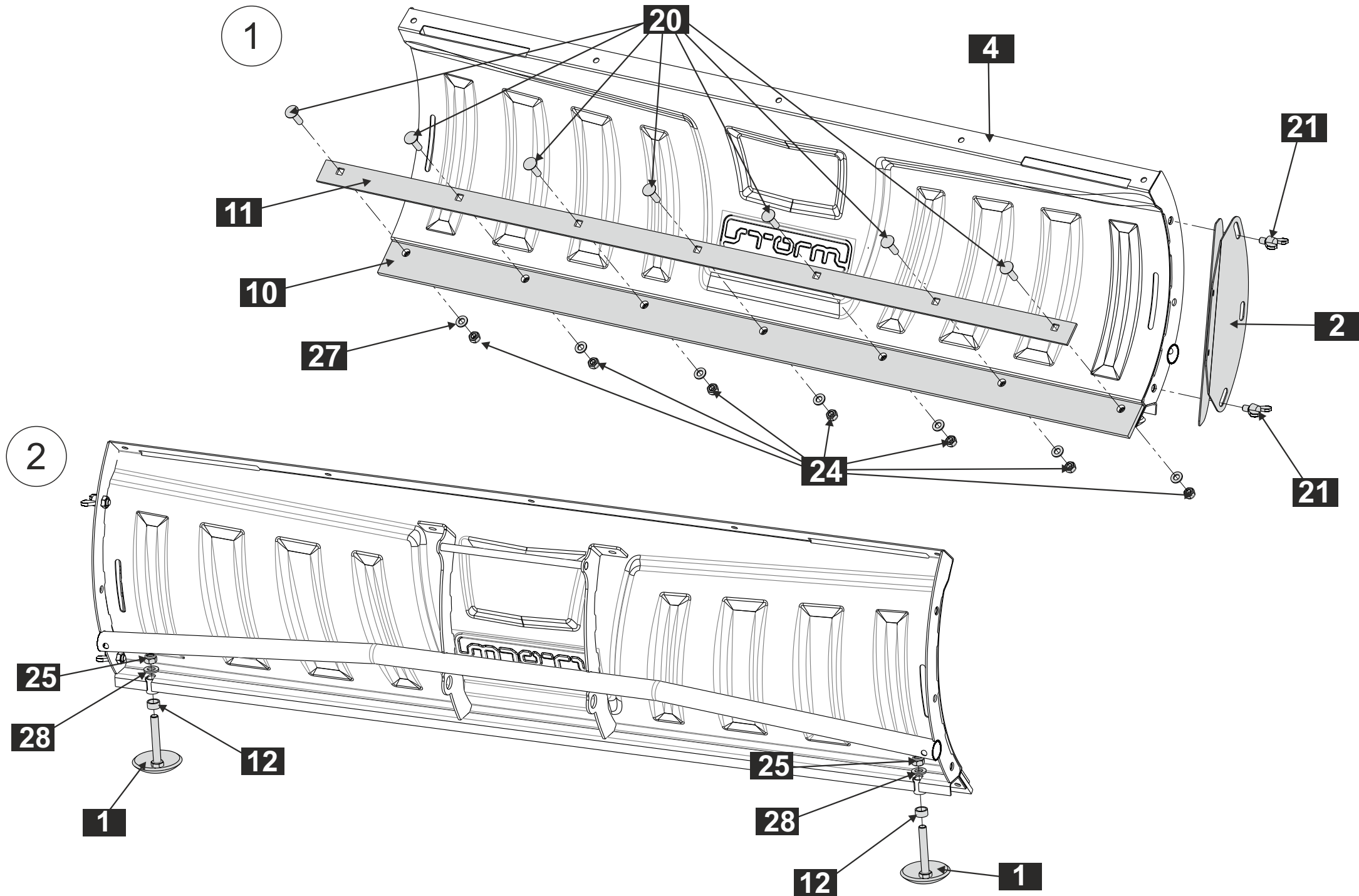

3

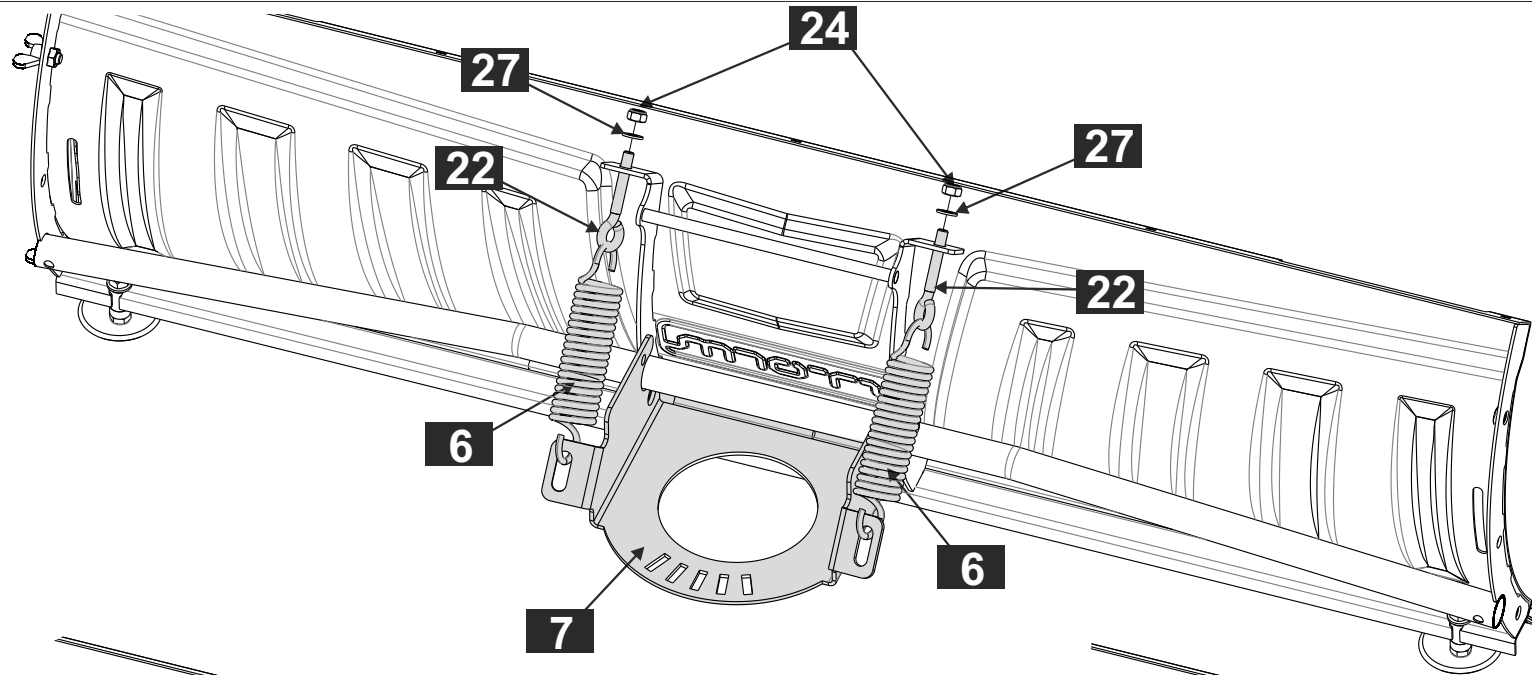

4

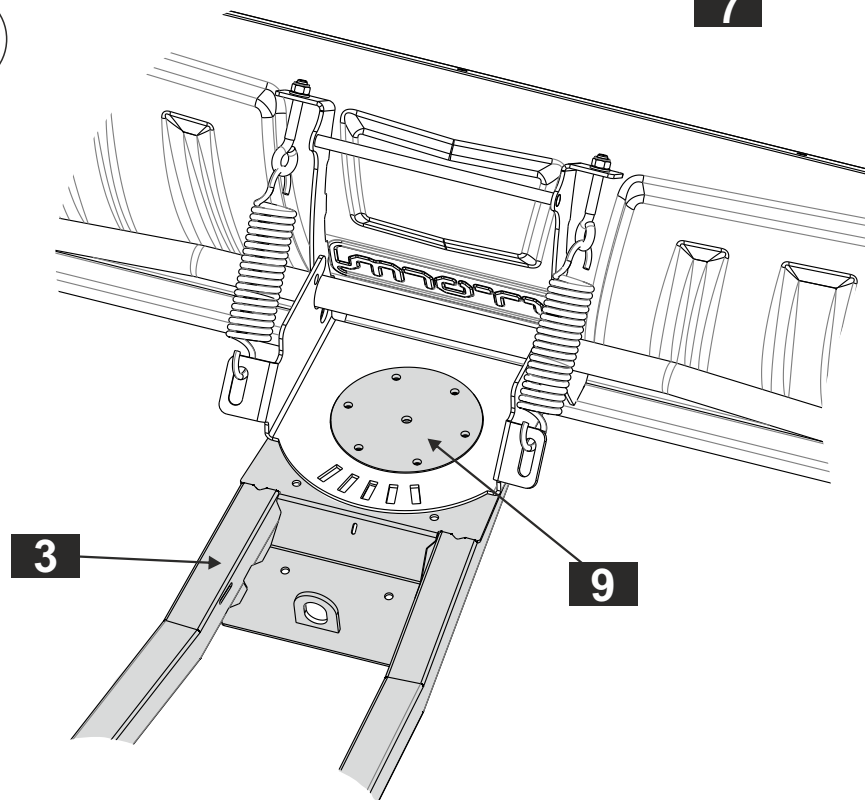

5

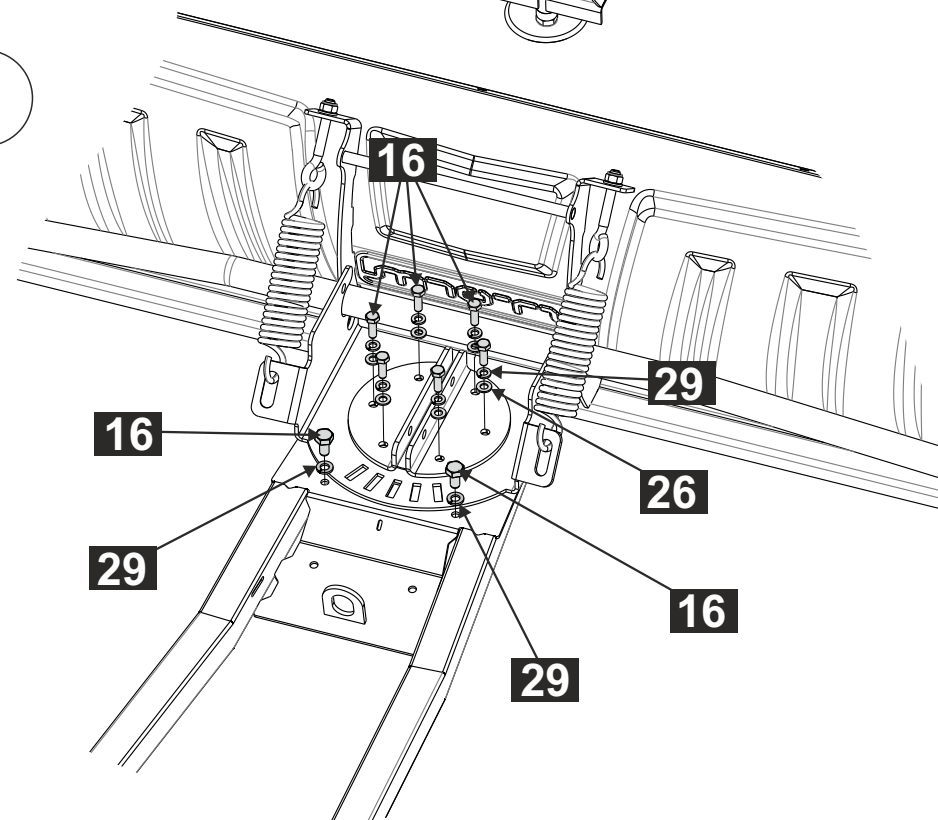

6

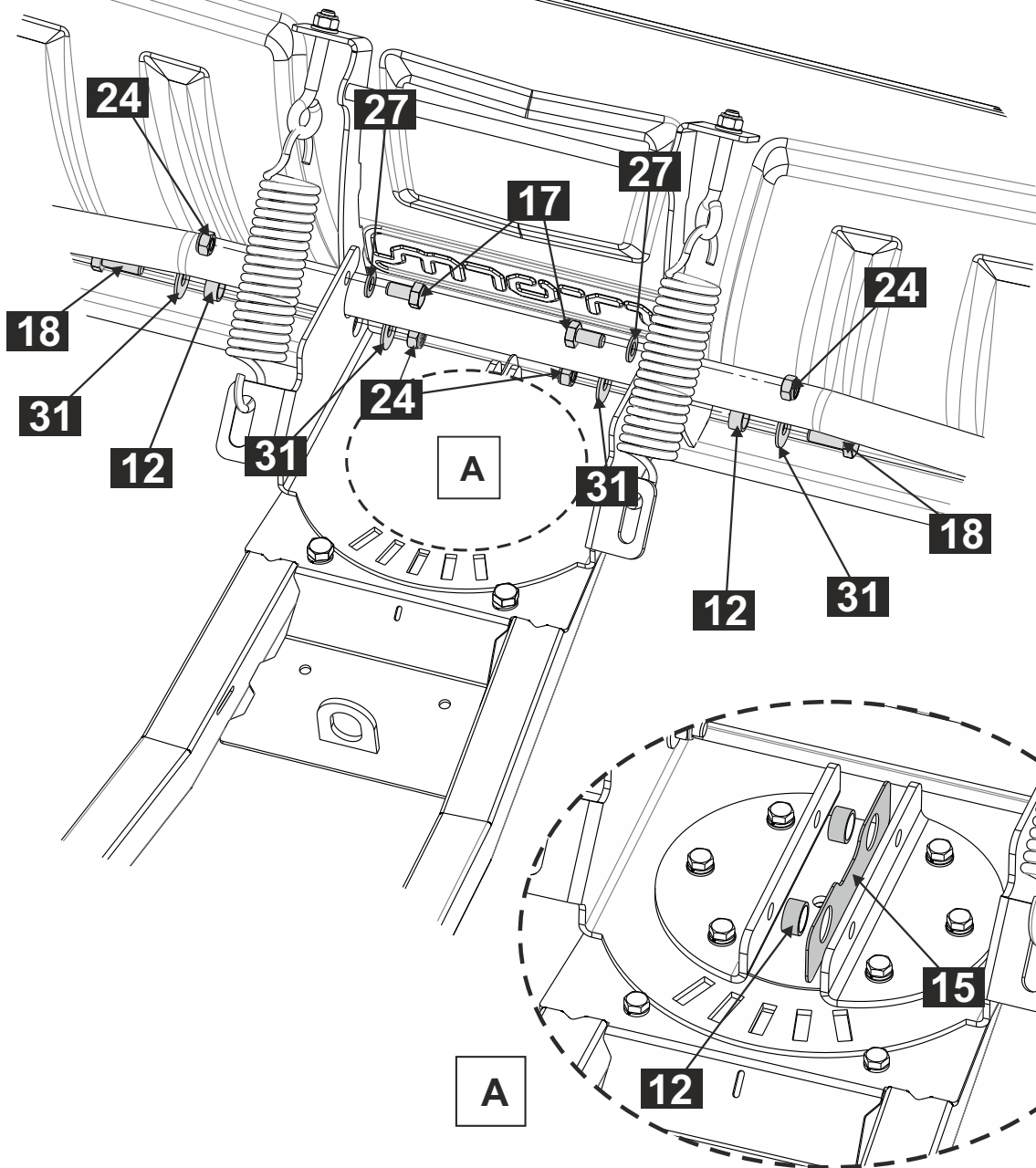

7

